

Varenummer: 203180M20200C4U

Beskrivelse: E+G Justerfod
GN 31-80-M20-200-C4-U

Note: U Uden møtrik, sekskant i toppen, spændeflade i bunden

Mål

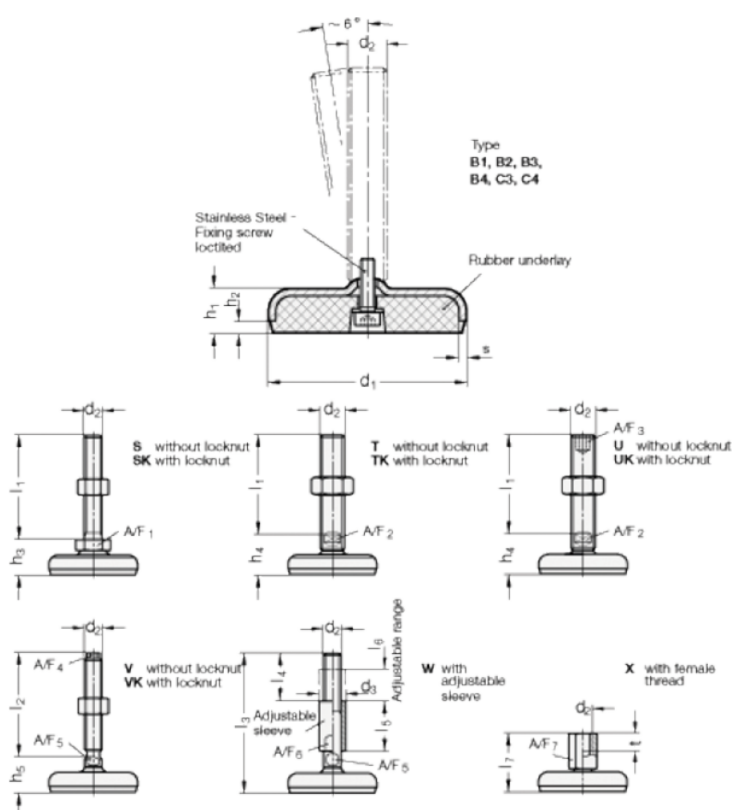

A/F2	= 15
A/F3	= 10
d1	= 80
d2	= 20
h1	= 18
h2	= 5
h4 +4.0/0	= 33
l1	= 200

s = 3